











INSTRUCTION MANUAL
MT700
VOLTAGE & CURRENT TESTER



Contents	Page no
1. Safety	4
1.1. International Safety Symbols.....	4
1.2. Safety Notes.....	4
1.3. WARNINGS.....	4
1.4. Safety Precautions before use.....	5
1.5. Safety Advices.....	5
2. Appropriate Usage	6
3. Meter Description	7
3.1. Meter Description.....	7
3.2. Symbols Used on LCD Display.....	8
4. Operation	9
4.1. Preparing the Test.....	9
4.2. Switching On and Off.....	9
4.3. Current Test.....	9
4.4. Voltage Test.....	10
4.5. Voltage and Current Measured Simultaneously.....	11
4.6. Rotary Field Indication.....	12
4.7. Resistance Test.....	12
4.8. Continuity Test.....	12
4.9. NCV Test.....	13
5. Cleaning	13
6. Battery Replacement	13
7. Specifications	14
7.1. General Specifications.....	14
7.2. Specifications.....	14

1. Safety

1.1. International Safety Symbols

-  **WARNING** of a potential danger, comply with instruction manual.
-  **CAUTION** dangerous voltage, Danger of electrical shock.
-  Double insulation.
-  Important information. Consult the instruction sheet.
-  Hazardous Voltage.
-  Suitable for live working.
-  This product complies with the WEEE Directive (2012/19/EU).
-  Conforms to European Union Directives.



CAT III Measurement Category III is applicable to test and measuring circuits connected to the distribution part of the building's low-voltage mains installation.

CAT IV Measurement Category IV is applicable to test and measuring circuits connected at the source of the building's low-voltage mains installation.

1.2. Safety Notes

- Reference, please use utmost attention.
- Do not exceed the maximum allowable input range of any function.
- Insulated personnel body protective equipment up to 1000V.
- The unauthorized persons are not to be allowed to disassemble the voltage detector.
- The voltages marked on the voltage detector are nominal voltages or nominal voltage ranges, and that the voltage detector is only to be used on installations with the specified nominal voltages or nominal voltage ranges.

1.3. WARNINGS

-  In order to avoid electrical shock, the valid safety and VOE regulations regarding excessive contact voltages must receive utmost attention, when working with voltages exceeding 120V (60V) DC or 50V (25V) rms AC, the values in brackets are valid for limited ranges (As for example medicine and agriculture).
-  Prior to measurement ensure that the test leads and the test instrument are in perfect condition.
-  When using this instrument only the handles of the probes may be touched-do not touch the probe tips.

- ⚠ This instrument may only be used within the ranges specified and within low voltage systems up to 1000V.
- ⚠ Prior to usage ensure perfect instrument function (e.g. on known voltage source).
- ⚠ The voltage detector is not to be used, if the battery cover is open.
- ⚠ The voltage detectors have to be kept dry and clean.
- ⚠ The voltage testers may no longer be used if one or several functions fail or if no functionality is indicated.
- ⚠ Do not use this instrument under damp conditions.
- ⚠ Accurate measurements within a temperature range of -10°C up to 55°C, at relative humidity question <85%.
- ⚠ If the operator's safety cannot be guaranteed, the instrument must be removed from service and sent in for repair.

1.4. Safety Precautions before use

- Meter shows obvious damage.
 - Test Leads are damaged or insulation is open.
 - Measurements are not correct.
- All relevant statutory regulations must be adhered to when using this instrument.

1.5. Safety Advices

- Depending on the internal impedance of the voltage detector and presence of interference voltage there could be a different capability of indicating the presence or absence of operating voltage.
- A voltage detector of relatively low internal impedance, compared to the reference value of 100kΩ, will not indicate all interference voltages having an original voltage value above the ELV level; When in contact with the parts to be tested, the voltage detector may temporarily discharge the interference voltage to a level below the ELV, but it will return to the original value when the voltage detector is removed.
- When the indication "Voltage Present" does not appear, it is highly recommended installing earthing equipment before proceeding with testing and maintenance.
- A voltage detector of relatively high internal impedance, compared to the reference value of 100kΩ, may not clearly indicate the absence of operating voltage in the presence of interference voltage.

- When the indication "Voltage Present" appears on a part that is expected to be disconnected from the installation, it is highly recommended confirming by another means (e.g. use of an adequate voltage detector, visual check of the disconnecting point of the electric circuit, etc.) that there is no operating voltage on the part to be tested and to conclude that the voltage indicated by the voltage detector is an interference voltage.
- A voltage detector declaring two values of internal impedance has passed a performance test of managing interference voltages and is (within technical limits) able to distinguish operating voltage from interference voltage and has the means to directly or indirectly indicate which type of voltage is present.

2. Appropriate Usage

- The instrument may only be used under those conditions and for those purposes for which it was manufactured. For this reason, the safety references, the technical data including environmental conditions and the usage in dry environments must be followed.
- When modifying or changing the instrument, the operational safety is no longer guaranteed.
- The instrument may only be opened by an authorized service technician.
- The voltage detectors are designed to be used by skilled persons and in accordance with safe work practice.
- Before using a voltage detector with audible indicator at locations with a high background noise level, it has to be determined whether the audible signal is perceptible.

3. Description

3.1. Meter Description

- | | |
|--------------------------------|---------------------------------|
| 1 - NCV | 11 - LED for Left Rotary Field |
| 2 - Current Jaws | 12 - LCD Display |
| 3 - NCV LED | 13 - Power and Mode Button |
| 4 - LEDs for Voltage Display | 14 - Flashlight and Hold Button |
| 5 - LED for AC Voltage | 15 - Flashlight |
| 6 - LED for Positive Voltage | 16 - Red Test Probe+ (L2) |
| 7 - LED for Negative Voltage | 17 - Black Test Probe - (L1) |
| 8 - LED for Warning Voltage | 18 - Battery Cover |
| 9 - LED for Right Rotary Field | 19 - Black Test Lead Input |
| 10 - LED for Continuity | 20 - Red Test Lead Input |

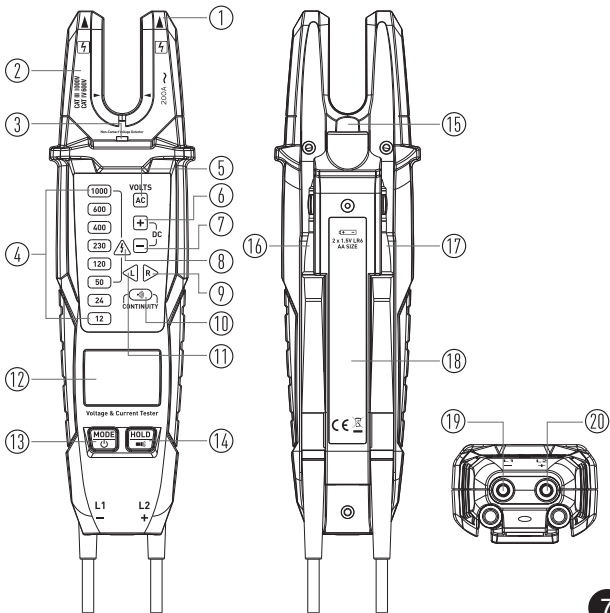

4. Operation

4.1. Preparing the Test

Prior to every test, please ensure that the instrument is in perfect condition:

- For example, keep an eye out for a broken housing, leaking batteries and damaged test leads.
- Always carry out a function test before using the voltage tester, see below.
- Check that the instrument is functioning properly (for example at a known voltage/current source) before and after every test.
- If the safety of the user can not be guaranteed, switch off the instrument and secure it to prevent unintentional usage.

4.2. Switching On and Off

- In the off state, press the **Power/Mode** Button to turn on.
- In the power-on state, press and hold the **Power/Mode** Button to switch off.

4.3. Current Test

- Put a single wire into the opening clamp head, and the LCD will display the current present.
- Place the wire in the correct position of the open jaw head, otherwise the measurement will be inaccurate.
- The LCD will display the reading.

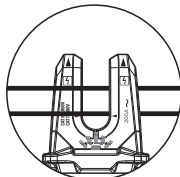

NO

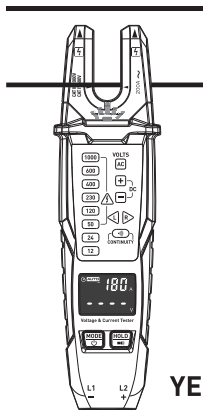

YES

4.4. Voltage Test

- Connect both test probes with power source.
- The voltage is displayed via LEDs, the measured voltage value will light up, the different indicating signals of the voltage detector (including the ELV limit indication) are not to be used for measuring purposes, the voltage is also shown on the LCD display.
- For AC voltage, the "AC" is illuminated; For positive voltage, the "+" is illuminated; For negative voltage, the "-" is illuminated.
- In the case of DC voltage, the polarity of the indicated voltage relates to the voltage tester probe tip.
- Once the safety extra-low voltage (50VAC/120VDC) is reached or exceeded, the "△" is illuminated, in the event of no battery power or main circuit failure.
- Once voltage is applied to the measuring instrument. press the **HOLD** Button, the LCD and LEDs display shows the recorded reading; To delete the recorded value, press the **HOLD** Button once again.

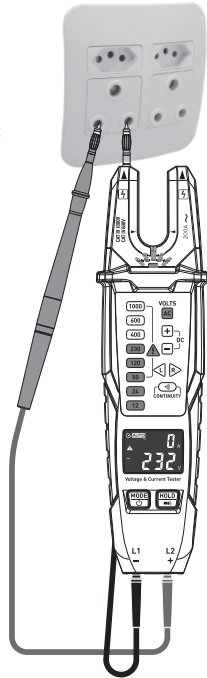

4.5. Voltage and Current Measured Simultaneously

- To simultaneously measure voltage and current, insert the test leads into the meter and switch the meter on.
- Connect the test leads to the power source. On the voltage display, the LCDs and LEDs will display the voltage measured.
- Place the clamp head over a single cable and the LCD display will show the Amperage reading that is been measured.
- For AC voltage, the "AC" is illuminated; For positive voltage, the "+" is illuminated; For negative voltage, the "-" is illuminated.
- In the case of DC voltage, the polarity of the indicated voltage relates to the voltage tester probe tip.
- Once the safety extra-low voltage (50VAC/120VDC) is reached or exceeded, the "△" is illuminated, in the event of no battery power or main circuit failure.
- Once voltage is applied to the measuring instrument. press the **HOLD** Button, the LCD and LEDs display shows the recorded reading; To delete the recorded value, press the **HOLD** Button once again.

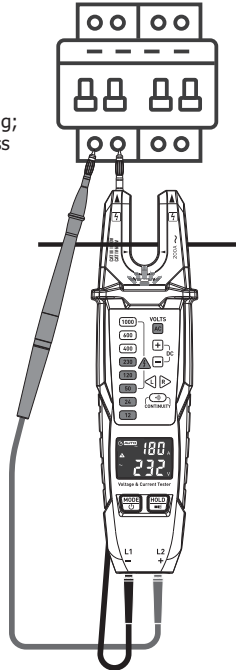

4.6. Rotary Field Indication

- The voltage testers are equipped with a double-pole rotary field indicator.
- The rotary phase indication is always active. the symbols "R" or "L" are always displayed, however the rotary direction can only be determined within a three-phase system, here the instrument indicates the voltage between two external conductors.
- Connect the instrument Red Test Lead (**L2+**) with the supposed phase L2 and the Black test lead (**L1-**) with the supposed phase L1, the voltage and the rotary field direction are displayed.
- "R" signifies that the supposed phase L1 is the actual phase L1 and the supposed phase L2 is the actual phase L2, "L" signifies that the supposed phase L1 is the actual phase L2 and the supposed phase L2 is the actual phase L1.
- The test result table is as follows:

Black Test Pen (L1-)	Red Test Pen (L2+)	Test Results
L1	L2	R
L2	L3	R
L3	L1	R
L1	L3	L
L2	L1	L
L3	L2	L
L1/L2/L3	N/PE	No Result
N/PE	L1/L2/L3	No Result

- Effective for voltages greater than 80Vrms.

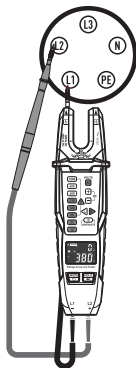

4.7. Resistance Test

- The Tester measures low ohm resistances between 1Ω and 1999Ω at a resolution of 1Ω.
- When you do a Resistance test make sure the UUT (Unit under test) is not live.

4.8. Continuity Test

- When you do a continuity test make sure the UUT (Unit under test) is not live.
- The continuity test is only possible when batteries are installed and in good condition, a signal sound is audible for continuity and the LED for continuity LED is illuminated.

4.9. NCV Test

- NCV cannot measure voltage, it can only sense whether there is voltage.
- NCV induced voltage is not less than 100V.
- Can only sense AC voltage.

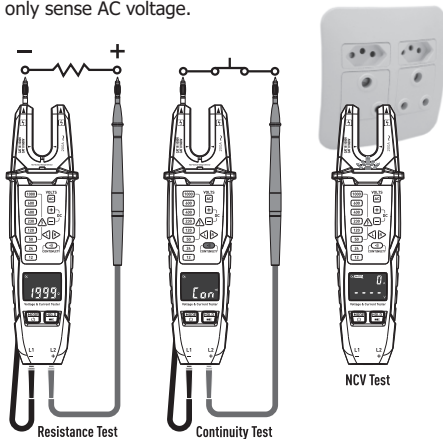

5. Cleaning

- Prior to cleaning, completely disconnect Voltage Tester from the measurement circuit.
- If the instruments are dirty after daily usage, it is advisable to clean them by using a damp cloth and a mild household detergent.
- Never use acid detergents or dissolvents for cleaning.
- After cleaning, do not use the voltage tester before confirming no moisture is present.

6. Battery Replacement

- When the battery symbol appears on the screen, replace the battery.
- Completely disconnect voltage tester from the measurement circuit.
- Remove the battery compartment screw, battery cover and batteries.
- Replace with new batteries, two type "AA" and check the correct polarity.
- Close the battery cover and re-screw the screw.

7. Specifications

7.1. General Specifications

Voltage Detection	Automatic
Polarity Detection	Full Range
Range Detection	Automatic
Measurement Principle	Double-pole and contact electrode
Safety Standards	EN61243-3:2014
Over Voltage Protection	1000V AC/DC
Measurement Category	CAT III 1000V / CAT IV 600V
Power Supply	2 x 1.5V "AA" Batteries
Power Consumption	Max. 100mA / approx. 300mW
Storage Temperature	-10°C up to 55 °C
Storage Humidity	Max. 85% relative humidity

7.2. Specifications

Function	Range	Resolution	Tolerances	Frequency
LEDs	12 TO 1000V AC/DC	± 12, 24, 50, 120, 230, 400, 690, 1000V AC/DC	Complies with EN 61243-3:2014	40 to 400Hz

Voltage	6 TO 1000V AC/DC	1V AC/DC	+3.0% of reading ±5 digit	40 to 400Hz
---------	------------------	----------	------------------------------	-------------

AC Current	0 to 200A AC	1A	+3.5% of reading ±5 digit	45 to 65Hz
------------	--------------	----	------------------------------	------------

Function	Range	Accuracy	Test Current
Continuity Test	0 to 400kΩ	Nominal resistance +50%	≤5μA

Function	Range	Resolution	Tolerance	Temperature Coefficient	Test Current
Resistance Measurement	0Ω to 1999Ω	1Ω	+ (5% rdg + 10 digits) at 20°C	±5 digits/10K	≤30μA

Function	Range	Frequency
Rotary Field Indication	(LEDs) 100 to 1000V	50/60Hz



MAJOR TECH (PTY) LTD

South Africa

🌐 www.major-tech.com

✉ sales@major-tech.com

Australia

🌐 www.majortech.com.au

✉ info@majortech.com.au

